







SYMETRICS Robinet d'arrêt à encastrer fermant à gauche 1/2" - Laiton brossé
(Or 23cts)

IMO

36 607 985



- rosace 60 x 60 mm
- tête de commande avec broche et douille à sectionner

	Laiton brossé (Or 23cts)	36 607 985-28
	Chrome	36 607 985-00
	Platine brossé	36 607 985-06
	Platine	36 607 985-08
	Or clair brossé	36 607 985-27
	Chrome brossé	36 607 985-93
	Dark Platinum brossé	36 607 985-99

Accessoires requis



- Robinet à encastrer 1/2" -** 35 607 970 90
- profondeur de montage max. 145 mm
 - profondeur de montage mini. 75 mm

36 607 985
mm [inches]

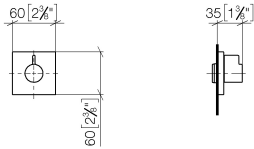

Certificats

DVGW_DW-
6501DN0116.
LGA_29932.

WRAS_2011026.

LGA_29931.

WRAS_2010066.

DVGW_DW-
6512DN0706.

36 607 985

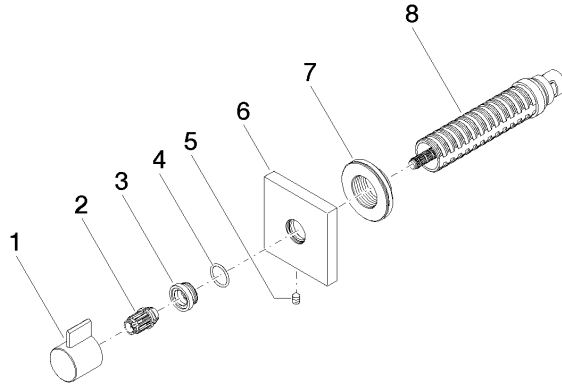

Liste des pièces de rechange

N°	Article Numéro	Désignation	Fréquence de montage	Délai de livraison
1	09 20 98 002-28	poignée	1	20
2	09 12 12 005 90	douille d'enclenchement	1	2
3	09 12 12 043-28	prise	1	20
4	09 14 10 017 90	joint	1	2
5	90 31 11 004 00 90	tige	1	2
6	09 27 98 014-28	rosace	1	20
7	09 21 02 151 90	douille	1	2
8	90 90 03 202 00 90	tête céramique	1	2